



Model No. RDU+ R2

Support 877-351-4702

ENHANCED DIGITAL COLOR LCD REMOTE DISPLAY UNIT FOR DFC+



This manual covers the following products:

- RDU+ Remote Display Unit +
- STS-1 Wall mount space temperature sensor 20-140°F (4-60°C)
- STS-2 Probe mount space temperature sensor 20-250°F (2-121°C)
- BAT Lithium Coin Battery CR2450

 <small>RECOGNIZED COMPONENT</small> <small>Intertek</small>	24VDC, 0.5A Max
	Conforms to UL STD 873
	Certified to CSA STD C22.2#24
	Control# 4007066

Table of Contents

Overview	2
Specifications	2
Installation	3
Normal Operation	4
Programming	4
Menus	4
Features	5-6
Paint Spray Booth	6
Menu Map	7-10

Overview

The Remote Display Unit+ (RDU+) is an enhanced remote digital control. The control has an eight button interface with a full color LCD. The RDU+ has one integrated temperature sensor and one external temperature sensor that can be connected to provide temperature sensing operation from 40°F (4°C) to 250°F (121°C). All programmable parameters can be accessed through the user setup menu with the eight button interface and LCD. The RDU+ schedule is a complete seven day agenda with adjustable times and settings. Diagnostic screens on the RDU+ provide monitoring of items on the RDU+ and DFC+ for maintenance. The RDU+ connects with the DFC+ using an RS485 serial communication. The RDU+ is powered by 24V DC from the DFC+. User parameters are stored in non-volatile memory, and are retained even during a power outage.

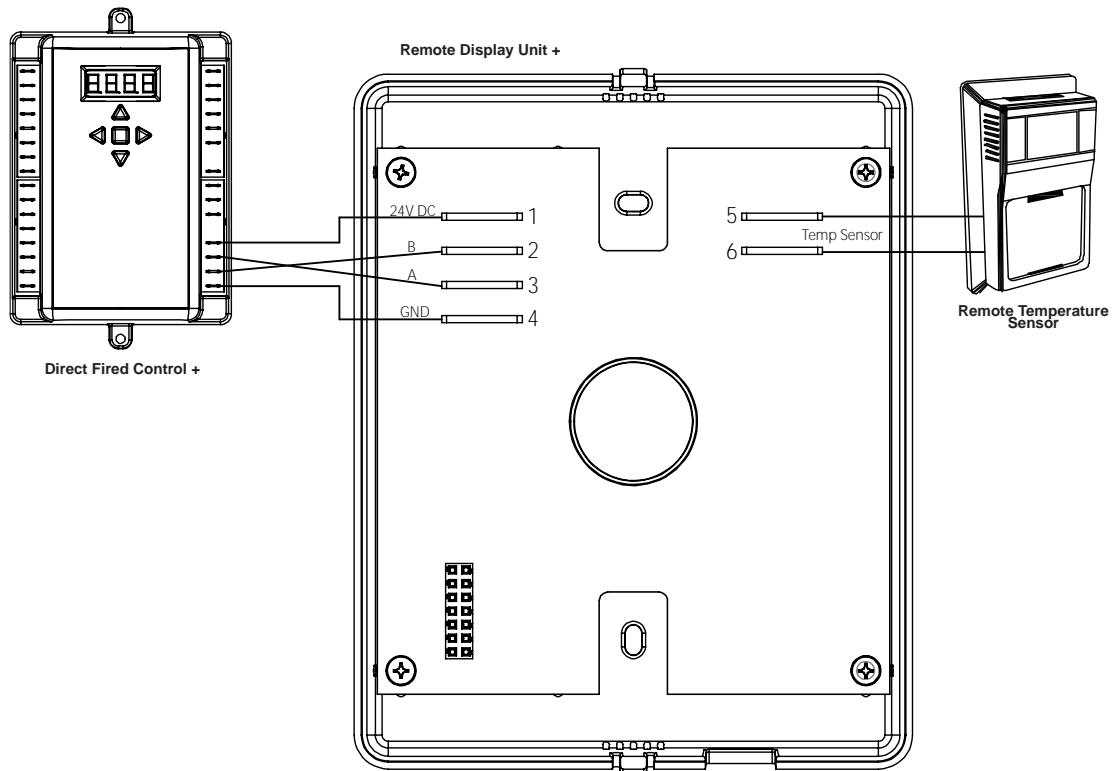

Figure 1: RDU+ Schematic Layout

Specifications

Power Requirements

RDU+ Control

RDU+ Real-time Clock

24V DC Supplied by DFC+
One Battery Lithium Coin (CR2450)

STS-1 Ambient Temperature Limits(1K PRTD)

Storage

-40-140°F (-40-60°C)

Operating

-40-140°F (-40-60°C)

STS-2 Ambient Temperature Limits(1K PRTD)

Storage

-40-250°F (-40-121°C)

Operating

-40-250°F (-40-121°C)

Accuracy

+/-3°F (1°C)

Installation

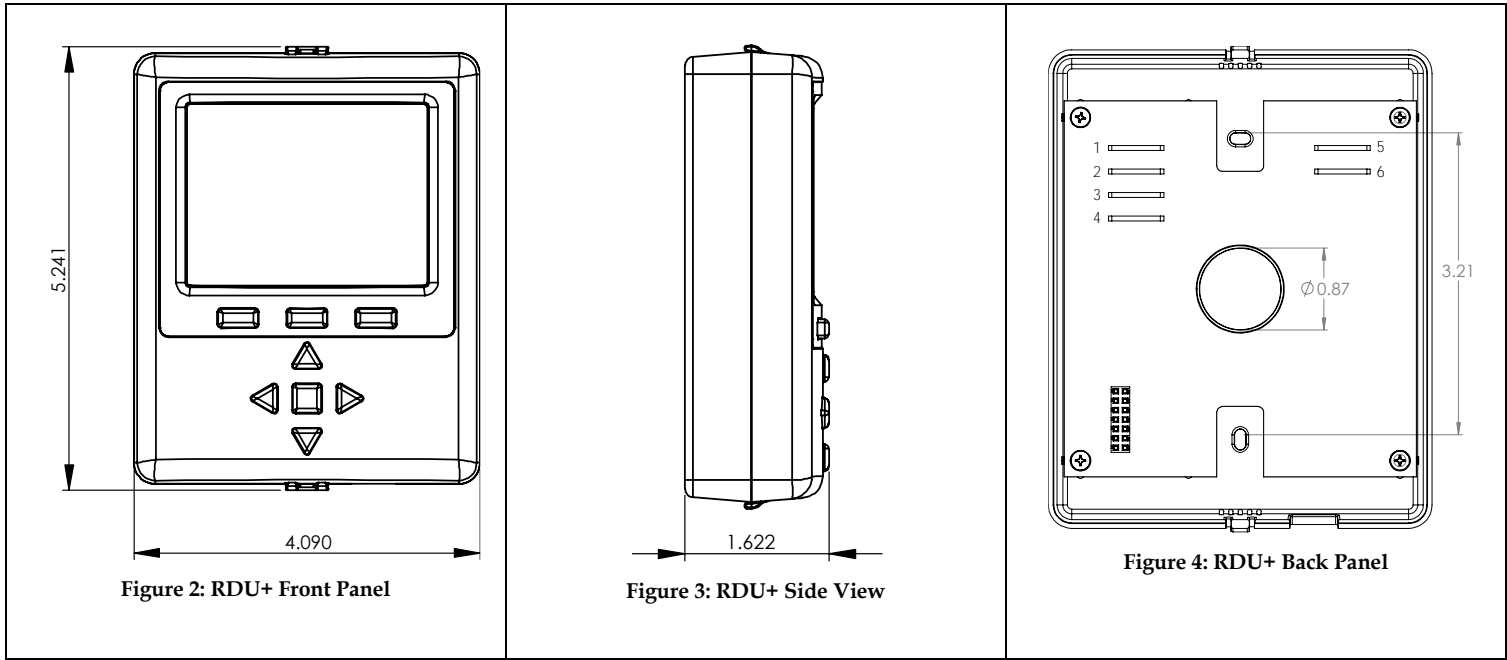

***All dimensions are in inches

The RDU+ may be directly wall mounted, attached to a conduit box, or used as a pendant.

Refer to Figure 4:

RDU+ Terminal Wiring

1	24V	RDU+ 24VDC
2	B	RS485 "B" Signal
3	A	RS485 "A" Signal
4	GND	RDU+ Ground
5	TMP	External Temp Sensor
6	TMP	External Temp Sensor

A strain relief may be added where a multi-wire cord is used.
Recommended strain relief:



Heyco Products, Inc.
Manufacturer Part #: 1832
Description: Cable Mounting

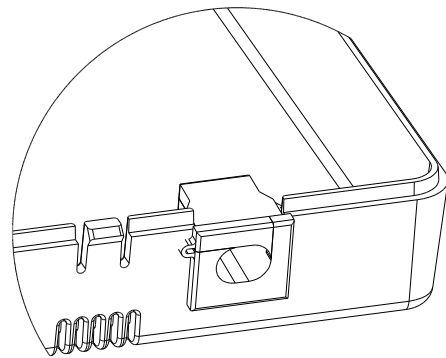
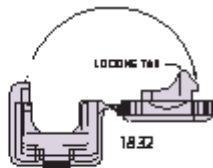
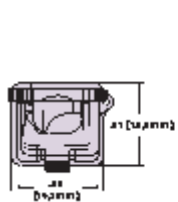
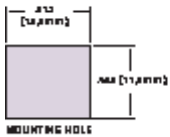

Figure 5: Strain Relief

Normal Operation

The time and day are displayed on the top left of the home screen. In the center of the LCD are four different temperature readings which are the Space Temp., Outside Temp., Discharge Temp., and the Setpoint. To change the current temperature setpoint use the **UP▲** or **DN▼** keys. Press the **ENT** key to save the changes made. There are three selections at the bottom of the display above their corresponding push buttons. On the home screen, the **BNT1** key controls the fan and can be set to on, off, or schedule. The **BNT2** key controls the Temperature and may be set to schedule, hold, or fan only. The **UP▲** and **DN▼** keys temporarily adjust the setpoint until the next timed schedule event. The hold selection will keep the current setpoint from changing. Use the **BNT3** key to access the systems menus. To select an option made by buttons 1-3 press the **ENT** key and to cancel a selection press the same **BNT1**, **BNT2**, or **BNT3** keys again.

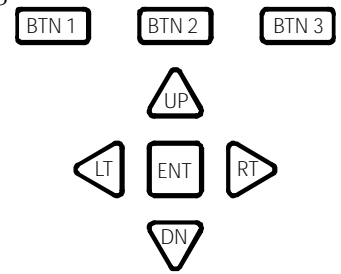

Figure 6: RDU+ Keys

Programming

To program a parameter in the RDU+, navigate through the menus using the eight button interface. If the password is enabled, a padlock icon will appear on the bottom right of the screen. If the password screen pops up, then enter the correct password "2014" to unlock the control. Once unlocked, after 60 seconds, the RDU+ will relock itself. There are 3 levels of password security and always a password to access the advanced setup items. Password level 1 locks out the system menu setup. Password level 2 only gives the user access to adjust the setpoint temperature. Password level 3 locks the user out completely.

When the control is unlocked, use the **BNT3** key to access the system menus and the **ENT** key to select the desired menu. Once inside the selected menu, use the **BNT1** key to scroll through the multiple pages and the **BNT3** key to access a different system menu. Use the **UP▲** and **DN▼** key to highlight a parameter. Press the **ENT** key to edit a parameter and the highlighted parameter will begin to blink. Use the **UP▲** and **DN▼** key to change the parameter and press the **ENT** key again to save changes. If a parameter has multiple sections then use the **LT◀** and **RT▶** keys to highlight them. For example, when updating the time in the setup menu there are multiple sections to change which are the hours, minutes, and am/pm.

Menus

Home	→	Brings the user to the home screen where the RDU+ normal operations take place.
Edit Schedule	→	Seven day schedule allowing the user to program the time of day, fan on or off, and the setpoint.
Programs	→	List of 10 editable programs, only for the Paint Spray Booth Application
Setup	→	System settings to adjust the system, fan, and remote setup parameters.
Diagnostics	→	Useful for technician's to detect item issues within the RDU+ and DFC+. Also, maintains a record of the last 8 alarms in the Message History.

Features

Applications:

- Make Up Air
- Warehouse
- Paint Spray Booth

Freeze Stat Control:

The RDU+ can control the DFC+ adjustable Freeze Stat remotely. The freeze stat prevents freezing air from entering the building in the event of burner failure. However, the freeze stat is optional and can be enabled or disabled in the RDU+ programmable settings. When enabled, the freeze stat setpoint temperature and time limit can be adjusted. The freeze stat setpoint allows the user to specify the cutoff temperature to shut down the burner and blower. If the systems inlet temperature rises back above the freeze stat setpoint, then the system will restart automatically. The freeze stat timer provides a time delay for the discharge temperature to rise above the setpoint. If it does not rise above the setpoint within the freeze stat time setting, the fan and burner will turn off. Once the freeze stat is tripped it can be reset remotely using the RDU+ or by cycling the power.

Operating Modes:

There are two control modes in the RDU+. In discharge mode, the output is driven directly by the setpoint temperature. In space mode, the control displays the current temperature in the space, and toggles the output between discharge minimum, the current setpoint, and discharge maximum to drive the space temperature to the current setpoint.

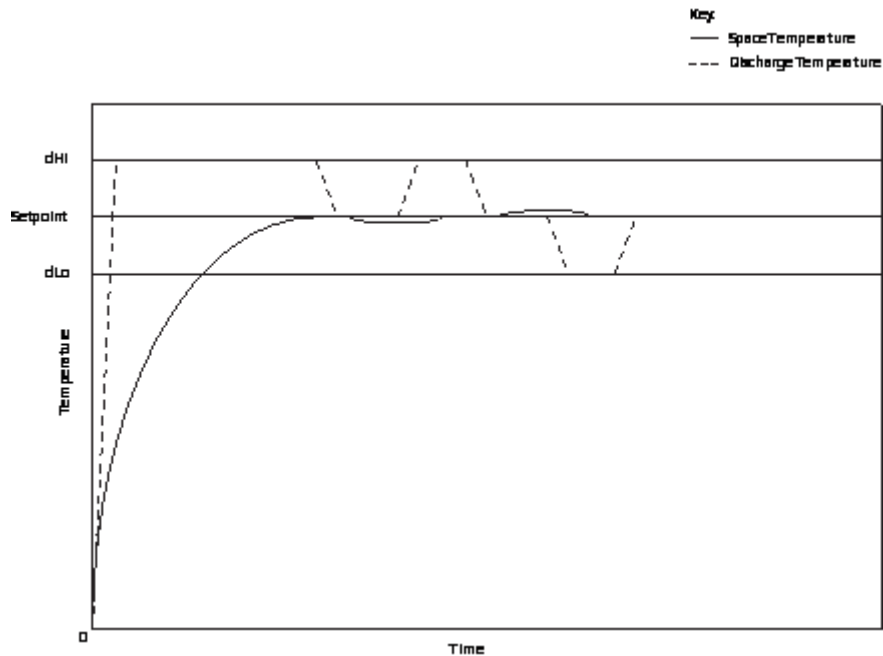

Figure 7: Space Mode

Alarms:

Error messages on the RDU+ will be displayed with a brief detailed message. This will allow users to realize the issue in order to resolve the error faster. Below are the two levels of errors...

- Alarms → Signaled by beeping and a text message highlighted in red. Press any key to silence the alarm and again to clear message.
- Warnings → Signaled by a text message in yellow. Stays at the bottom of the screen.
- FSC Alarm → Flame Safety Control signaled as an Alarm. Press any key to silence the alarm and again to clear message. Press Button 2 to bring up the FSC popup and the Enter key in order to reset the FSC.

Automatic Thermostat:

The RDU+ can control the DFC+ automatic inlet thermostat with an adjustable heat and cool deadband remotely. The range of the deadband is programmable from 2°F - 10°F. The burner turns on when the inlet temperature falls below the setpoint minus the heating deadband range. The cooling turns on when the inlet temperature rises above the setpoint plus the cooling deadband range. This allows for the system to save energy and use the outside temperature in order to cool or heat. After the system turns on there is an automated hysteresis of two degrees before the system turns off again.

For example, the system setpoint is at 70°F and both the heat and cool deadband are set to 3°F.

Parameters set: System Setpoint 70°F, Heating deadband 3°F, Cooling deadband 3°F

If the inlet temperature reaches 74°F then the cooling will turn on because of the set deadband range. If the inlet temperature reaches 66°F then the heating will turn on because of the set deadband range.

Inlet temperature rises above $70^{\circ}\text{F} + 3^{\circ}\text{F} = 73^{\circ}\text{F}$, at 74°F cooling on
Inlet temperature falls below $70^{\circ}\text{F} - 3^{\circ}\text{F} = 67^{\circ}\text{F}$, at 66°F heating on

With the systems 2°F hysteresis the burner or cooling will not turn back off until the discharge temperature reaches 71°F or 69°F.

Inlet temperature with hysteresis $74^{\circ}\text{F} - 2^{\circ}\text{F} = 72^{\circ}\text{F}$, at 71°F cooling off
Inlet temperature with hysteresis $66^{\circ}\text{F} + 2^{\circ}\text{F} = 68^{\circ}\text{F}$, at 69°F heating off

Paint Spray Booth

To use the Paint Spray Booth Application go to the Setup screen from the system menus and switch the application to Paint Spray Booth. There are 10 editable Programs with 10 editable Steps within each Program. The Programs are flexible with the option to change the Program name, Step names, Step time length, and temperature setpoint. A touch screen keyboard is available to create custom Program and Step names preferred by the user. There is a list of predefined Step names to select from. The Step names "End" and "Shutdown" are coded in the software to specify when a Program ends and a Program must include one of these option. The Step name "End" leaves the fan on, while "Shutdown" turns the fan off. To begin a program, press button 2 to launch the first step "Spray" in the Program. The Step name "Spray" is always the first step in a Program and the time during this step does not expire. Press button 2 again to start additional timed steps. See Paint Spray Booth menu map for more detailed information.

Standard Home Screen:

Time and Date →

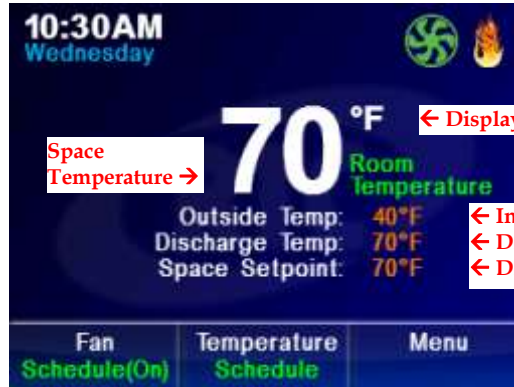

← Displays current setpoint when editing Setpoint

Space Temperature →

← Inlet Temperature

← Discharge Temperature

← Discharge or Space Setpoint

↑ Button 1 Fan Control ↑ Button 2 Temperature Control ↑ Button 3 Menus

Home Screen Pop-up Menus:



↑ Fan: Manual On, Off, or use Schedule

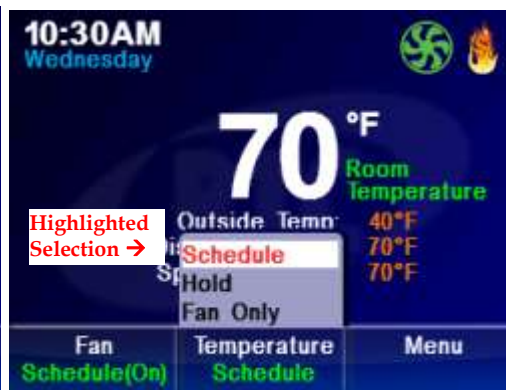

↑ Temperature: Use Schedule, Fan Only, or Hold

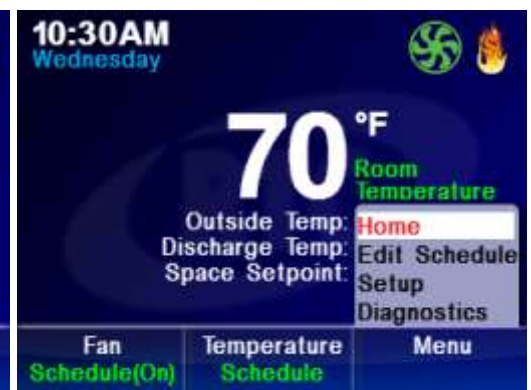

↑ Menu to all system screens. Home, Setup, Schedule, and Diagnostics Screen

Home Screen Warning and Alarm:



Alarm signaled by beeping and message. Press any key to silence alarm and again to clear message.



Warning signaled by a message. Press any key to clear message.



Toggles Relay for the Freeze Stat Control

Menu Setup Screen:

Key Notes
 Password level 1 gives user access to change the setpoint.
 Password level 2 locks the user out from making any changes.

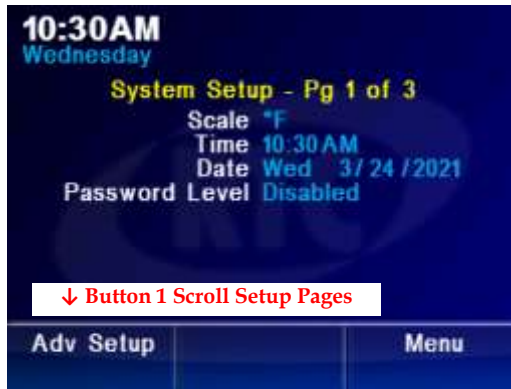

- ← Converts the system unit to either °F or °C
- ← Update the controls real-time clock
- ← Update the Date for the control
- ← Enable or Disable the password.

Key Notes
 Discharge Minimum ranges from 40-240°F and must be at least 10°F less than the Max.
 Discharge Maximum ranges from 50-250°F and must be at least 10°F more than the Min.



- ← Set lowest the discharge setpoint can reach (Min 40°F)
- ← Set highest the discharge setpoint can reach (Max 250°F)
- ← Deadband range to turn on cooling if exceeded
- ← Deadband range to turn on heating if exceeded
- ← Enable or Disable the Freeze Stat
- ← Delay Timer before the Freeze Stat trips
- ← Cutoff temperature to shut down the burner and blower

Key Notes
 Setpoint Minimum ranges from 40-240°F and must be at least 10°F less than the Max.
 Setpoint Maximum ranges from 50-250°F and must be at least 10°F more than the Min.



- ← Select application for RDU+ usage
- ← Set lowest the Setpoint can be adjusted (Min 40°F)
- ← Set highest the Setpoint can be adjusted (Max 250°F)
- ← Determine whether to use Discharge or Space mode
- ← Determine whether to use the onboard local sensor, remote sensor, or the average between the two sensors

Password Screen:

Key Notes
 The Password Screen is used as a touch screen. Tap the arrows on the screen in order to scroll the numbers and enter the correct 4 digit password "2014".

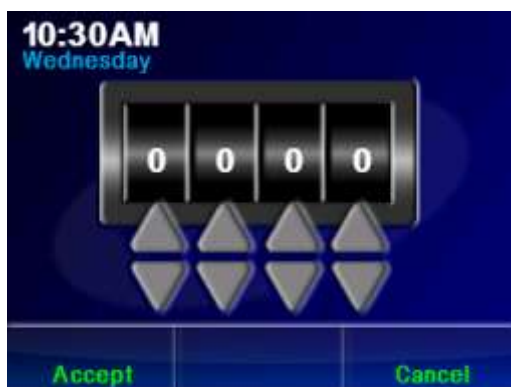

- ←Four Digit Password
- ←Touch Screen Arrows

↑ Button 1 Submit Password Button 3 ↑ Return Home

Schedule Setup Screen:

Key Notes
 Use the arrow keys to maneuver around the schedule until the property to be changed is highlighted. Once highlighted, press the ENT key to select the property. Use the arrow keys to update the property and ENT to save changes.

The screenshot shows a schedule setup screen for Wednesday at 10:30 AM. At the top, there are buttons for 'Set Time' and 'Set Fan'. Below is a table with the following data:

Time	Fan	Temp
Time 1	On	80°F
Time 2	On	80°F
Time 3	On	80°F
Time 4	On	80°F

Below the table are buttons for 'Copy Day', 'Paste Day', 'Next Day', 'Edit', and 'Menu'. Navigation instructions are provided: 'Day of the week' with a right arrow, 'Temperature Setpoint' with a left arrow, 'Button 1 Scroll Days' with an up arrow, 'Button 2 Copy & Paste Day' with an up arrow, and 'Button 3 Menus' with an up arrow.

Key Notes
 The Schedule is taken into effect when Temperature or Fan on the Home Screen is set to "Schedule".
 In order to copy and paste a day, have the day to be copied visible. Press BTN2 and select copy. Then Scroll to the day to be pasted with BTN1. Press BTN2 and select paste.

Diagnostics Screen:

The screenshot shows the RDU+ diagnostics screen at 10:30 AM on Wednesday. It displays 'RDU+ Items - Pg 1 of 3' with the following data:

Local Temp	70°F
Remote Temp	70°F
TB Software rev#	V1.00
LB Software rev#	V2.02.3
Bad CRCs	0

Buttons for 'Next' and 'Menu' are visible at the bottom.

RDU+ showing the values of the temperature sensors and bad CRCs which are failed communications between the RDU+ and DFC+ RS485.

The screenshot shows the DFC+ diagnostics screen at 10:30 AM on Wednesday. It displays 'DFC+ Items - Pg 2 of 3' with the following data:

CO2	1000PPM	Relays
Outside Temp	40°F	Fan Off
Discharge Temp	70°F	Heat Off
Current Setpoint	70°F	Cool Off
0-10V Input	10.00V	AC Inputs
0-10V Output	10.000V	Airflow Off
PWM Output	0%	Alarm Off
Software rev#	V2.03.5	Fan Off
Bad CRCs	0	C.Filter Off

Buttons for 'Next' and 'Menu' are visible at the bottom.

DFC+ items showing the various input and output values. Also shown are the positions of the Relay Switches and AC Inputs.

The screenshot shows the RDU+ Message History screen at 10:30 AM on Wednesday. It displays 'Message History - Pg 3 of 3' with the following data:

01/ 01 12:00PM	Airflow alarm
01/ 01 12:00PM	Airflow alarm
01/ 01 12:00PM	Airflow alarm
01/ 01 12:00PM	Airflow alarm
01/ 01 12:00PM	Airflow alarm
01/ 01 12:00PM	Airflow alarm
01/ 01 12:00PM	Airflow alarm
01/ 01 12:00PM	Airflow alarm

Buttons for 'Next' and 'Menu' are visible at the bottom. Navigation instructions are provided: 'Date, Time, and Alarm' with a right arrow and 'Button 1 Scroll Pages' with a right arrow.

RDU+ keeps a record of the eight most recent alarms. Used to quickly figure out an issue

Paint Spray Booth Home Screen:



When a program isn't running, the Current Step Name will read "Prep" and Button 2 will read "Spray" on the Home Screen

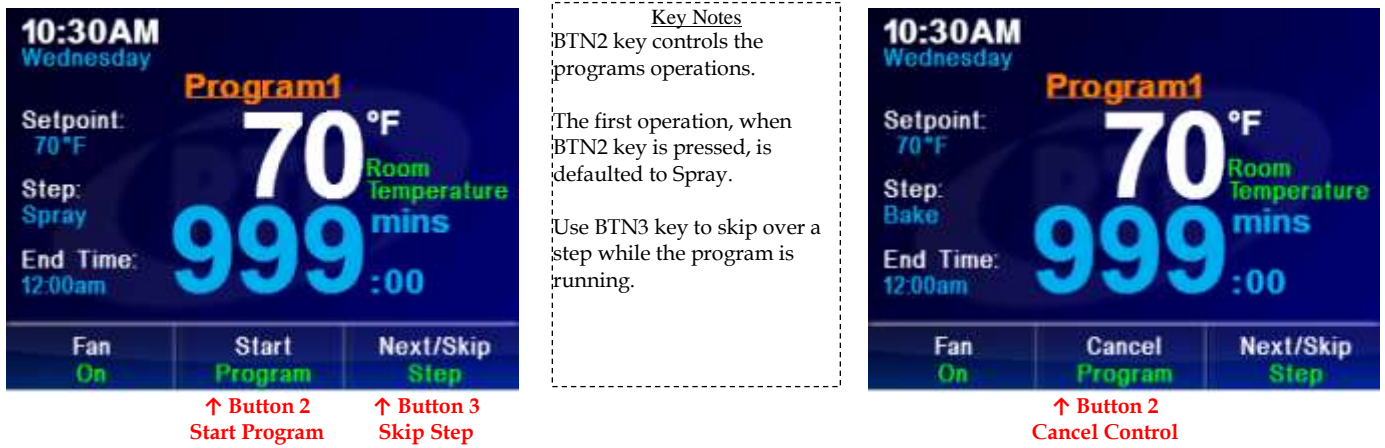

Once button 2 is pressed, the current step name will display "Spray", button 2 will display "Start Program", and button 3 will display "Next/Skip Step" on the Home Screen. When button 2 is pressed again, the program and timer counter will begin. The step will display "Step 2" and button 2 will read "Cancel Program" on the Home Screen. To cancel a program anytime, press button 2 once more. If a program was canceled, to continue where a user left off, restart the program and skip through the steps using button 3 until the preferred step is reached. If a program was not canceled, the steps in the program will continue the remaining steps 2 - 10 in order until "End", "Shutdown", or the completion of step 10 is reached.

Paint Spray Booth Program Screen:



↑ Button 1 Select Program ↑ Button 2 Edit Program

Key Notes

RDU+ stores up to 10 Paint Spray Booth Programs.

The BTN1 Key returns the user to the Home Screen with the highlighted Program as the newly selected program.

The BTN2 Key brings the user to the Step Screen to edit the highlighted program.

Paint Spray Booth Step Screen:



↑ Button 1 Next Screen

Key Notes

RDU+ stores up to 10 Step Names per a Program.

The BTN1 Key switches through the 10 steps.

To edit a field, highlight the field by using the arrow keys and the ENT key to select the field.

To edit a Program or Step name. Highlight the name and use the ENT key. The keyboard will appear.

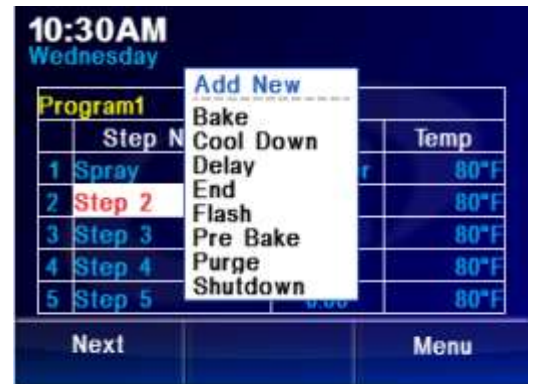

RDU+ keeps a record of eight predefined step names for convenience or the user may create one by selecting "Add New" from the list.

Paint Spray Booth Keyboard Screen:



Key Notes

The keyboard is touch screen and may be used with your fingers or soft objects.

BTN1 key saves the name change.
BTN2 key cancels the name change.
BTN3 key clears the name field.

SHFT – Uppercase or Lowercase letters
SPC – Space
BKSP – Backspace
1,# – Numbers and Symbols